

# Excel in productivity

Ultimate quantitative performance made possible

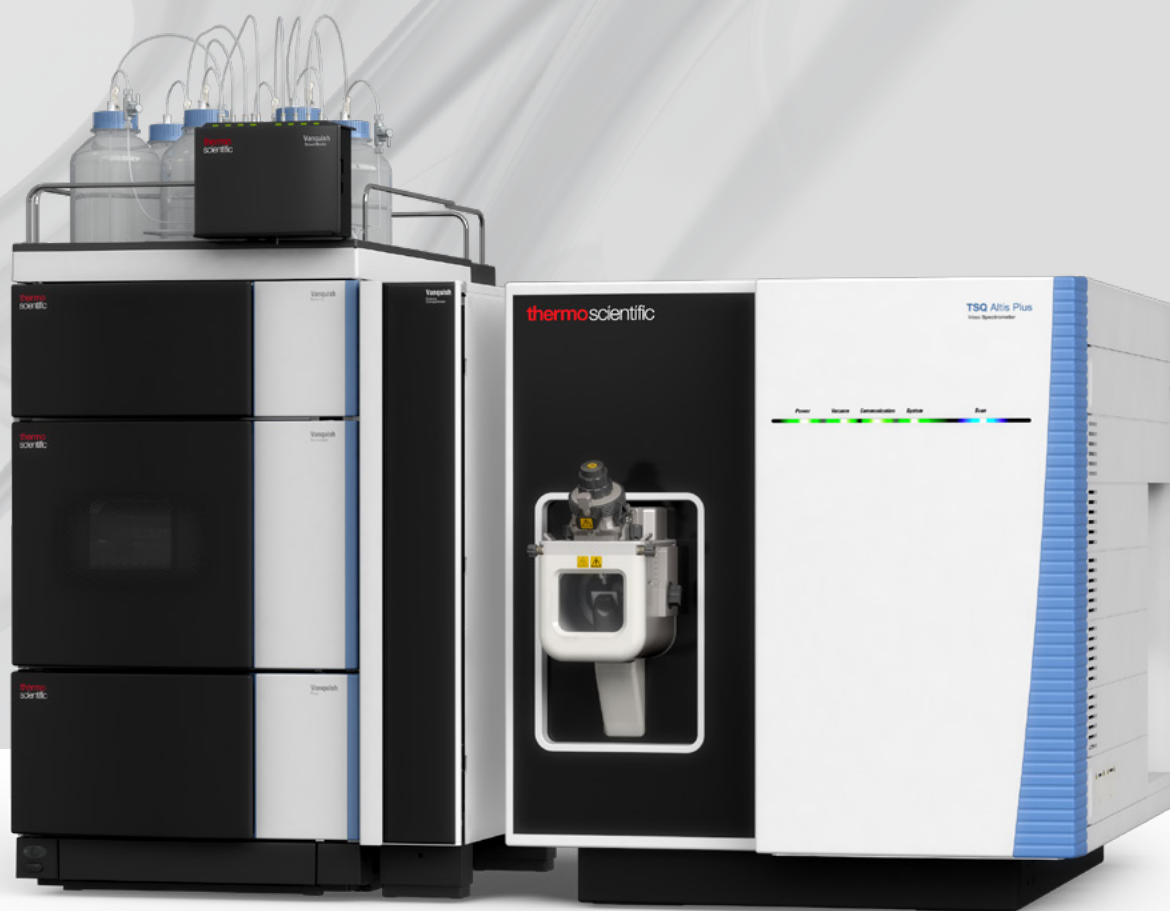

TSQ Altis Plus triple quadrupole mass spectrometer

# Advance your quantitative capabilities: TSQ Altis Plus MS with **AIM+** Technology

**Active Reaction Collision Cell II (ARC II) with axial DC fields**  
Enables ultra-fast selected reaction monitoring (SRM).

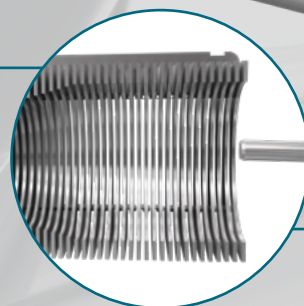
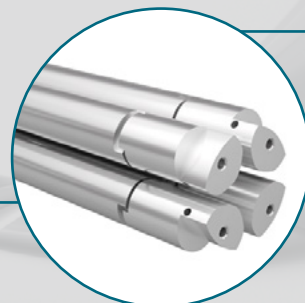
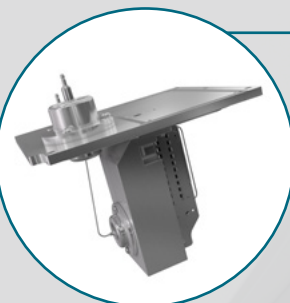
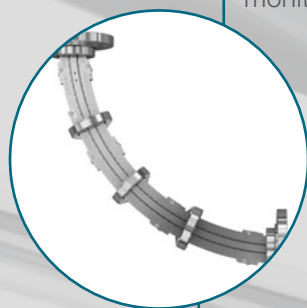

**Optimized high-capacity transfer tube (HCTT)**  
Maximizes ion introduction while maintaining robustness.

**Electrodynamic Ion Funnel (EDIF)**  
Efficient capture and gentle movement of ions from the HCTT into the vacuum region provides ultimate sensitivity.

## No compromises: supreme quantitative performance

Laboratory needs for productivity grow relentlessly. New methods target more compounds at lower levels in less time with expectations of increased confidence. The Thermo Scientific™ TSQ Altis™ Plus triple quadrupole mass spectrometer combines innovative instrument hardware and software advancements to deliver robust, sensitive, and efficient targeted quantitation workflows to meet scientific and business goals every day for every sample.

## Sensitive, selective, fast

Innovations in the mass analyzer, active collision cell, and RF electronics offer high sensitivity, selectivity, and more data points with superior acquisition speeds and polarity switching times. You can confidently quantify compounds at extremely low concentrations, in the most challenging matrices.

## Robust, reliable, reproducible

The TSQ Altis Plus MS is designed for stable, reliable, and consistent performance. Novel ion optics, source design, and enhanced mass analyzers deliver superior robustness, reduce maintenance, and increase reproducibility. Every TSQ Altis Plus MS produces results that you can have confidence in every day.

# Active Ion Management Plus (AIM+) Technology

The next step in precision design delivers the ultimate in ion management, inception to detection, from the Thermo Scientific™ OptaMax™ NG ion source housing to the enhanced electron multiplier. AIM+ Technology incorporates QR5 segmented quadrupoles and enhanced RF electronics to further optimize ion management precision, reliability, speed, and reproducibility.

## Confident by design

The TSQ Altis Plus triple quadrupole mass spectrometer is designed with confidence in mind. It delivers superb sensitivity and excellent robustness and reliability for all applications, thereby enabling confidence in your results—day in and day out.

### Enhanced dual-mode discrete-dynode electron multiplier detector

Extends multiplier lifetime with increased surface area. Maintains excellent linearity and dynamic range.

### QR5 Plus segmented quadrupole mass filters with hyperbolic surfaces

Improved mass stability and accuracy requiring less frequent calibration and greater productivity.

### Ion beam guide with neutral blocker

Provides robust performance and maximum sensitivity by blocking neutrals and efficiently transmitting ions.

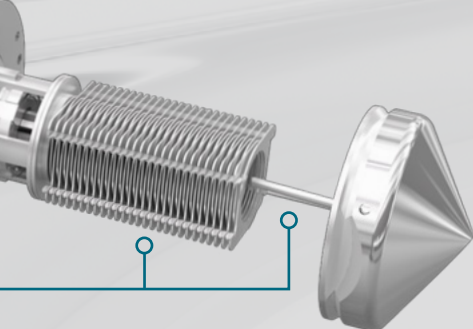

### OptaMax NG ion source APCI-ready

Streamlines all gas and voltage connections for ease-of-use. Provides optimizable spray position for ultimate performance in HESI or APCI mode.

## Effortless productivity

The TSQ Altis Plus mass spectrometer provides practical ease-of-use and performance features to increase sample throughput.

- Simple maintenance (no need to break vacuum) and intuitive calibration routines
- Customizable and application-specific instrument templates with easy and direct method importation
- Curated SRM information for more than 10,000 compounds with Thermo Scientific™ mzCloud™ database integration
- Automated compound optimization
- SRM visualization and optimization with dwell time prioritization
- Streamlined data review and reporting

## Facilitating method set-up with mzCloud database integration

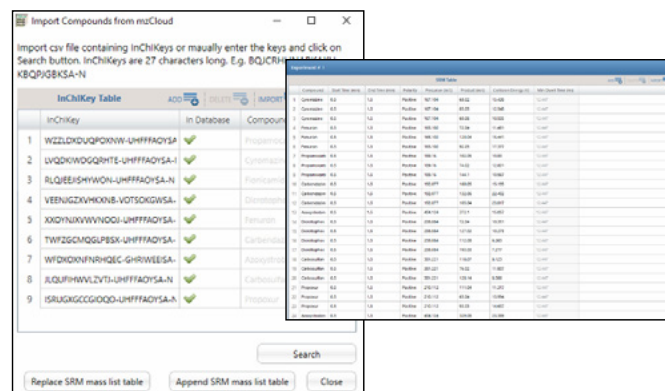



# Make your **Pharma** and **Biopharmaceutical** research workflows more productive

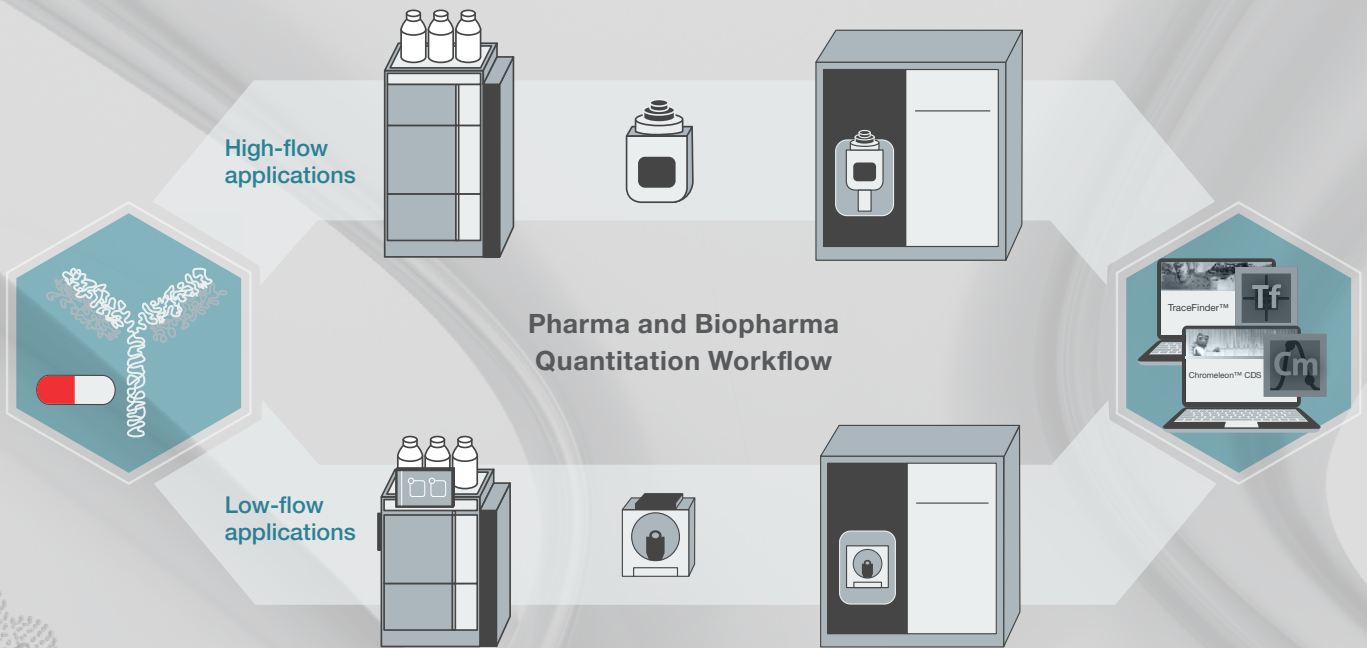

The industry-leading sensitivity and selectivity of the TSQ Altis Plus mass spectrometer make it an ideal instrument for developing targeted quantitation assays that can quantify all types of molecules at ultra-low levels in complex biological matrices.

- **Ease-of-use**—simplified workflows with exceptional performance from nano to analytical flow rates
- **Enhanced selectivity**—improved quantitation with highly selective reaction monitoring (H-SRM) and the optional Thermo Scientific™ FAIMS Pro Duo interface
- **Ultimate sensitivity**—low-level analyte quantitation in the most challenging assays

## Increased selectivity with High-resolution SRM (H-SRM)

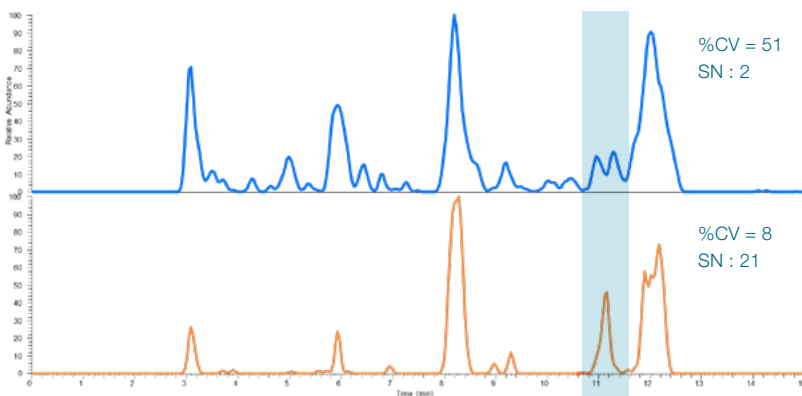

Comparative SRM trace for the Anti-FAP monoclonal antibody 4B9 surrogate peptide LLIIIGASTR spiked into mouse plasma at 20 ng/mL

## Improved specificity enables lower levels of quantitation

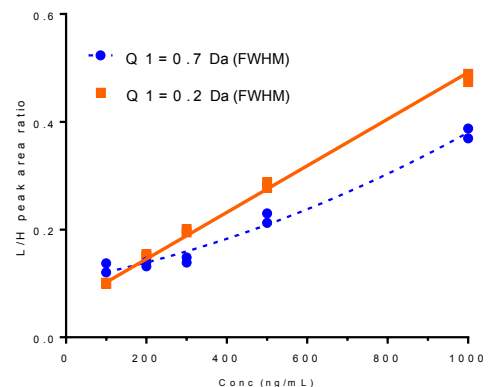

Q1 resolution benefits evaluated for the Anti-FAP monoclonal antibody 4B9 surrogate peptide LLINVGSR spiked into mouse plasma. Both sets of SRM transitions were measured within one instrument method.

# Meet Clinical Research and Forensic Toxicology testing requirements

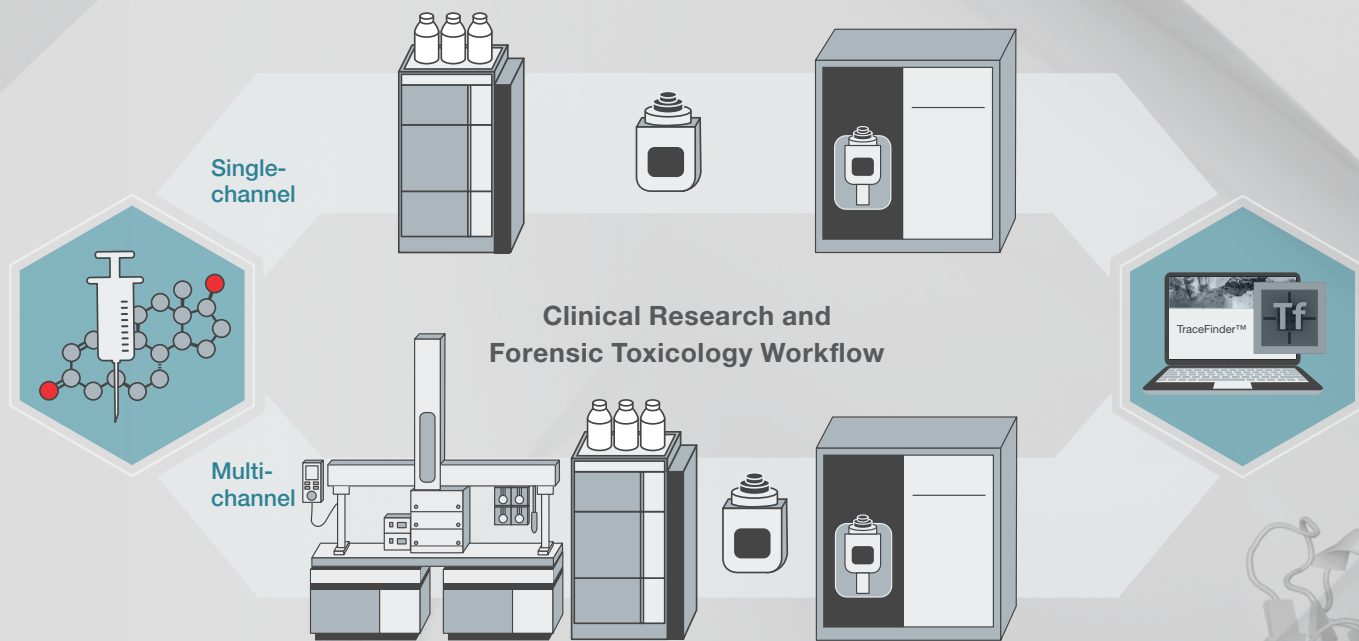

Clinical research and forensic toxicology applications demand high sensitivity, selectivity, precision, and reliability to detect and quantify steroids, illicit drugs, and infectious disease markers in the presence of complex biological matrices. In addition, expanded target lists and UHPLC separation require faster acquisition speeds to maintain the experimental scope. The TSQ Altis Plus mass spectrometer provides superior targeted quantitative performance to deliver confident results for low-level compounds in complex matrices.

- **Increase productivity**—with simplified workflows and multi-channel technology to maximize throughput
- **Intuitive software**—empowers users to create and modify experimental methods with ease
- **Improved mass analyzers**—enhance operational stability at maximum selectivity—day after day

Ultimate acquisition speed and performance is required for large-scale lipid profiling

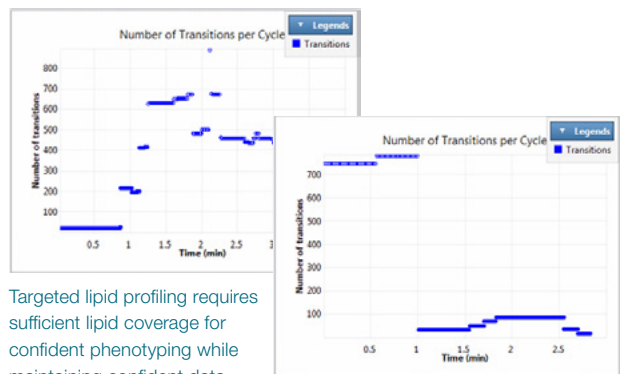

Targeted lipid profiling requires sufficient lipid coverage for confident phenotyping while maintaining confident data acquisition. The current profiling method contains more than 1500 scheduled SRM transitions in negative ESI mode (left) and 850 in positive mode using less than 1 ms dwell times per ionization mode.

Demonstrating quantitative performance using <1 ms dwell times

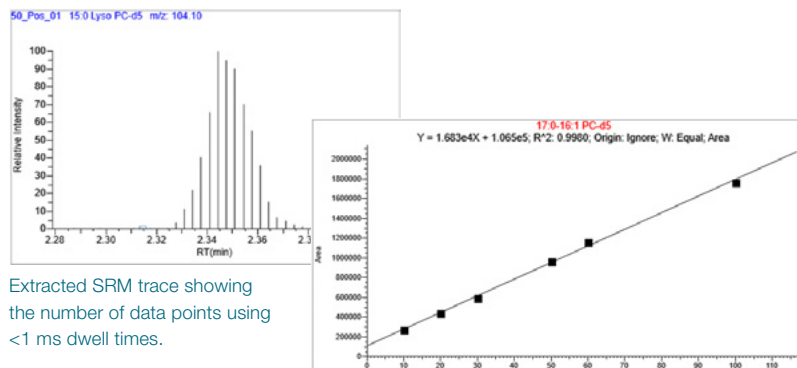

Extracted SRM trace showing the number of data points using <1 ms dwell times.

Demonstrated quantitative capabilities of the TSQ Altis Plus MS using <1 ms dwell times.

# Keep up with the high-sensitivity demands of Environmental and Food Safety testing



New challenges in environmental and food safety emerge every day. Evolving regulations and emerging contaminants require rapid method creation or adaptation to meet quantitation demands. The TSQ Altis Plus mass spectrometer delivers robust quantitation, outstanding reproducibility, ultimate sensitivity, and superior acquisition speeds for hundreds of contaminants at ultra-low levels, providing the highest confidence in your workflows.

- **Increased workflow productivity**—acquisition speed to quantify more compounds per unit time
- **Intuitive software**—enables fast and confident method creation, expansion, and optimization
- **Integrated processing software**—simplified data visualization and customized reporting
- **Ultimate method flexibility**—market-leading online and offline sample preparation with UHPLC and HPIC options

Reliably meeting sensitivity limits for polar pesticides in challenging matrices using IC-MS/MS separations

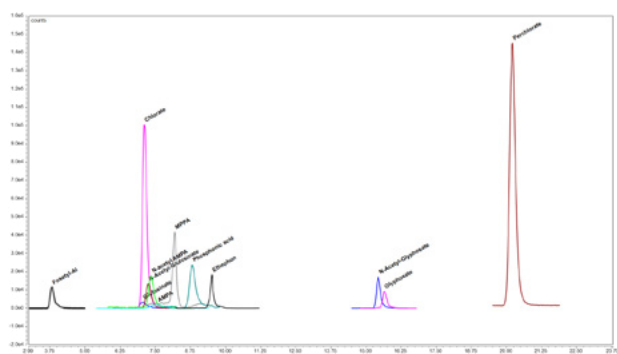

Targeted quantitation of polar pesticides at 25 pg on column. Efficient ion chromatographic separation improves method robustness.

Confident quantitation of challenging analytes. Powerful LC- and IC-MS/MS solutions for environmental analysis.

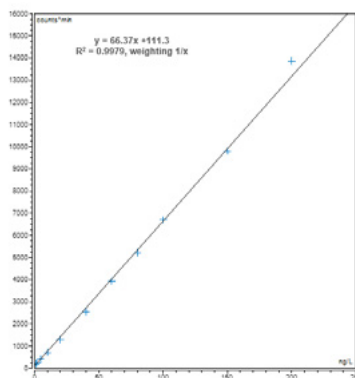

Direct injection analysis of PFOA from wastewater over a calibration range of 5 to 200 ng/L.

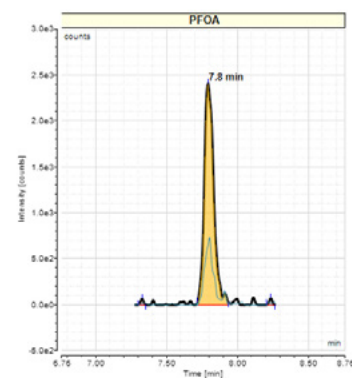

Overlaid SRM traces for PFOA at 25 fg on column demonstrating quantifying and qualifying ions.



# Companion solutions for the TSQ Altis Plus mass spectrometer

## Workflow-driven software, solutions, and support streamline your applications

Integrated workflow-driven software and solutions streamline everyday tasks—from instrument optimization and troubleshooting to routine method development and results reporting.



### Thermo Scientific™ TraceFinder™ software

Comprehensive quantitative workflows for all applications—from method development to report generation



### AppsLab method library

A comprehensive repository for application methods, data sets, and application notes



### Thermo Scientific™ Chromeleon™ software

Offers enterprise instrument control, data processing, and ability to address regulatory requirements



### Thermo Scientific™ mzCloud™ mass spectral library

The world's largest LC-MS<sup>1</sup> reference spectral library for an expansive and chemically diverse compound collection

Our global Centers of Excellence, in-your-lab training using your methods, and AppsLab library of analytical applications ensure your success.

## Chromatography solutions for MS

The TSQ Altis Plus mass spectrometer can be paired with a range of high-performance Thermo Scientific™ inlet systems.

- Thermo Scientific™ Vanquish™ Neo, Core, Flex, Horizon, and Duo UHPLC systems
- Thermo Scientific™ Transcend™ II system with Multi-channel and TurboFlow™ technology
- Thermo Scientific™ Transcend™ LX-1, LX-2, and LX-4 UHPLC systems
- Thermo Scientific™ Transcend™ TLX-2 and TLX-4 UHPLC systems
- Thermo Scientific™ Dionex™ ICS-6000 Capillary HPLC™ system
- Thermo Scientific™ Dionex™ Integrion™ HPLC™ system
- Thermo Scientific™ TriPlus™ RSH EQuan 850 system



# Transforming triple quadrupole mass spectrometers

The TSQ Altis Plus mass spectrometer is one in a portfolio of latest-generation Thermo Scientific™ triple quadrupole mass spectrometers that offer confident quantitation every day, for every lab and every user.

These instruments are built on a foundation of shared, state-of-the-art hardware and software components. This makes it easier to transfer methods from one instrument to another when methods progress from single, sample-based experiments to validation and routine, high-volume targeted screening and quantitation.



## Almanac web-based monitoring and management

Stay connected to your science. See how the Thermo Scientific™ Almanac™ application can help you get the most out of your instruments.

[thermofisher.com/almanac](https://thermofisher.com/almanac)



## Technical and online support: peak performance for your instruments

Helping you keep your instruments running at peak performance is our goal. Whether you're looking for an instrument manual or spare parts, want to submit a repair request, or check on the status of your warranty or service contract, we have every support option you're looking for.

[thermofisher.com/technicalresources](https://thermofisher.com/technicalresources)



## Protecting your investments: unparalleled laboratory services

Unity™ Lab Services provides a single source for integrated lab service, support, and supply management. Our customized service offerings and world-class service experts have the flexibility and experience to address your laboratory's needs. We provide a complete portfolio of services and support solutions designed to help you improve productivity, reduce total cost of ownership, and ensure performance throughout your laboratory.

[unitylabservices.com](https://unitylabservices.com)

Find performance at [thermofisher.com/AltisPlus](https://thermofisher.com/AltisPlus)

**ThermoFisher**  
SCIENTIFIC